

19945	32653	32654	32655	32656
05503	07782	11979	19938	19939
05494	05495	05496	05497	05498
05485	05486	05487	05488	05489
05476	05477	05478	05479	05480
05484	05483	05482	05481	05490
05493	05492	05491	05500	05499
05502	05501	19941	19940	19943
19944				

1

*
x2
x3
x4
x5

2

OLB KNOXOX COPRHOI ASTRAVOC

Comercializado por: ASTRAL POOL S.L.U. NIF A-17583105. Avda. Francesc Macià, 38 Planta 15, 08208 Sabadell, Barcelona, Spain. www.astralpool.com
Fabricado por: NIF A-08246274

- We reserve the right to change all or part of the articles or contents of this document, without prior notice.
- Nos nous réservons le droit de modifier totalement ou en partie les caractéristiques de nos articles. Il de le contenu de ce document sans pré-avis.
- Nos reservamos el derecho de cambiar total o parcialmente las características de nuestros artículos o contenido de este documento sin previo aviso.
- Ci riserviamo il diritto, senza preavviso, di cambiare, totalmente o parzialmente, il contenuto di questo documento.
- Wir behalten uns das recht vor die merkmale unserer produkte und den inhalt dieser beschreibung ohne vorherige ankuendigung ganz oder teilweise zu aendern.
- Reservavimo-nuos as drafte de alytar, totali ou parciaimente as charakteristcas dos nossos artigos ou o contedo deste documento sem aviso previo.
- We behouden het recht om alle artikelen of een gedeelte van de artikelen en/of de inhoud van dit document te veranderen, zonder voorgaande vermelding.
- Forbholder oss retten til å endre hele dokumentet eller enkelte avsnitt av dokumentet uten forvarsel.
- Forbeholder os retten til at ændre hele dokumentet eller enkelte afsnit uden forudgående varsel.
- Vi forbeholder oss retten til å endre hela dokumentet eller delar av det, utan forvaring.
- Päättämme oikeuden muuttaa kokonaan tai osittain tämän asiakirjan tietoa ilman ennakkoilmoitusta.
- Zadržujeme si právo změny urd zcela nebo áste n charakteristky na ich v robk, nebo obsah tohoto dokumentu bez p edchozho upozom ni.
- We rezervam dreptul de a schimba o parte sau toate produsele aferente documentului, fara o notificare in prealabil.
- Danasame ce pravoto da pmonenime vovkiv ili naci cast or aprimuyvite ili naci pkrmeneto na toai donuyveto, bez preapredimeno isvestie.
- Fentartjuk a jogot termekünk tulajdonságainak illőve e dokumentum tartalmának részleges vagy teljes megváltoztatására, előzetes figyelmeztetés nélkül.
- Vyřazujeme si právo změnit zcela nebo částech charakteristky našich výrobků nebo obsah tohoto dokumentu bez předchozího upozornění.
- Διατηρούμε το δικαίωμα αλλαγής μέρους ή του συνόλου των όψεων ή των χαρακτηριστικών αυτού του εγχειριδίου χωρίς καμία προειδοποίηση.
- 在沒有預先通知的情況下，我們保留更改全部或部分內容的權利。

3

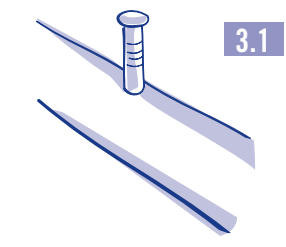

3.1

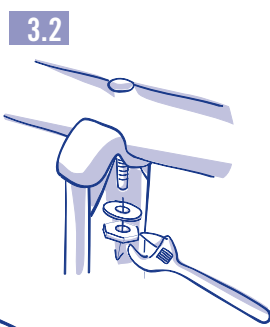

3.2

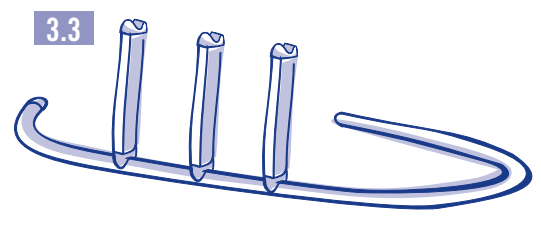

3.3

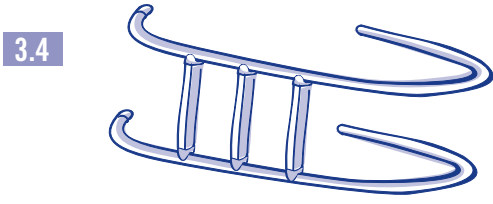

3.4

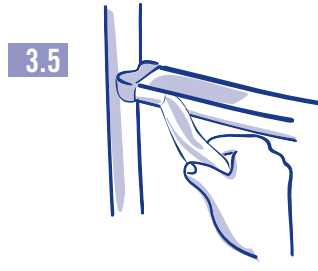

3.5

4

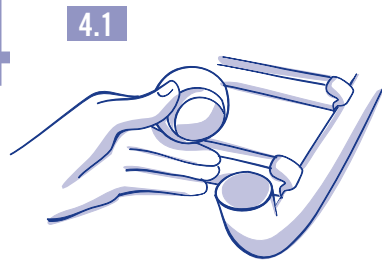

4.1

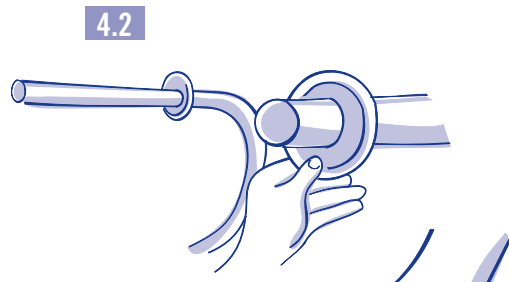

4.2

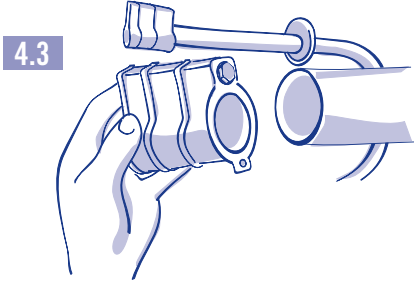
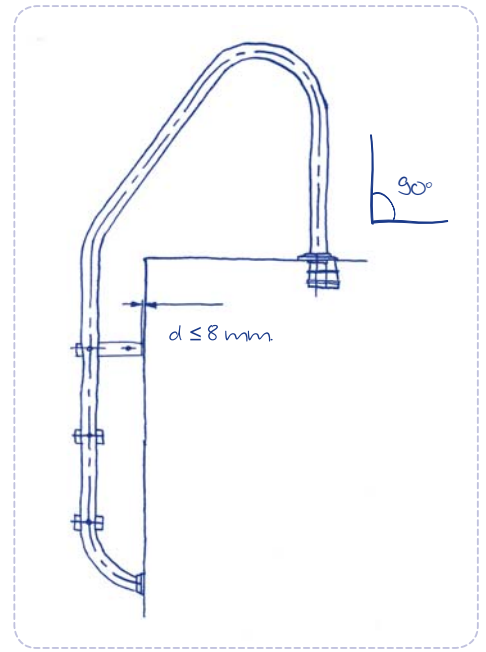

4.3

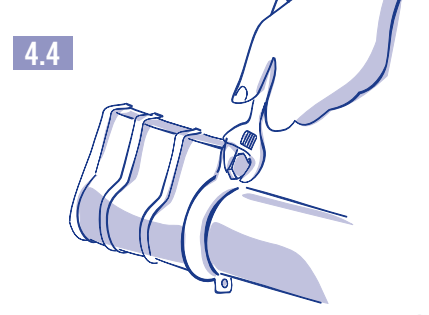

4.4

5

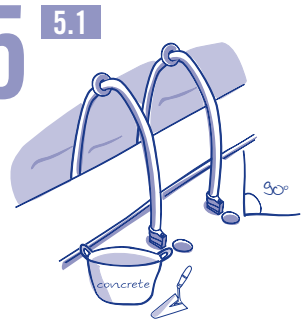

5.1

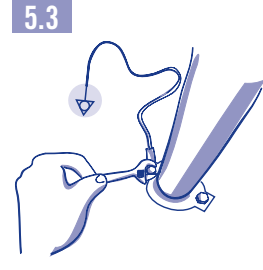

5.3

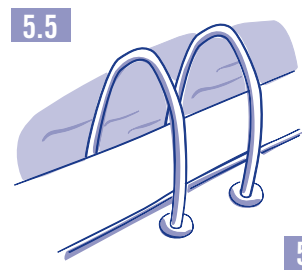

5.5

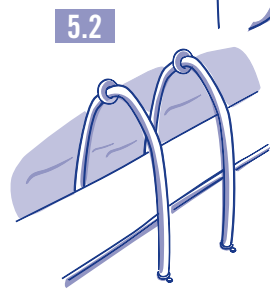

5.2

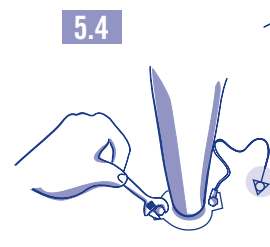

5.4



5.6

6

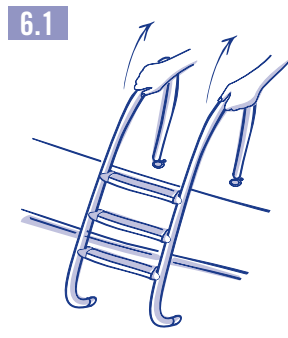
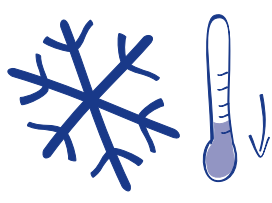

6.1

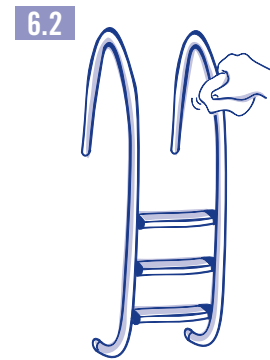

6.2

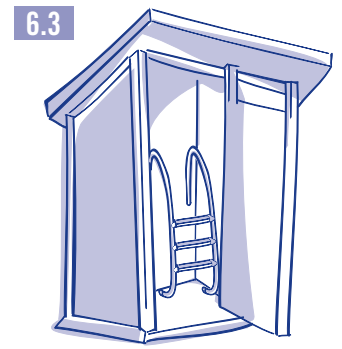

6.3